



**rBOX101-FL Series**  
**Robust Din-rail Fanless Embedded**  
**System User's Manual**



## **Disclaimers**

This manual has been carefully checked and believed to contain accurate information. AXIOMTEK Co., Ltd. assumes no responsibility for any infringements of patents or any third party's rights, and any liability arising from such use.

AXIOMTEK does not warrant or assume any legal liability or responsibility for the accuracy, completeness or usefulness of any information in this document. AXIOMTEK does not make any commitment to update the information in this manual.

AXIOMTEK reserves the right to change or revise this document and/or product at any time without notice.

No part of this document may be reproduced, stored in a retrieval system, or transmitted, in any form or by any means, electronic, mechanical, photocopying, recording, or otherwise, without the prior written permission of AXIOMTEK Co., Ltd.

**©Copyright 2010 AXIOMTEK Co., Ltd.  
All Rights Reserved  
August 2011, Version A1  
Printed in Taiwan**

## Safety Precautions

Before getting started, please read the following important safety precautions.

1. The **rBOX101-FL** does not come equipped with an operating system. An operating system must be loaded first before installing any software into the computer.
2. Be sure to ground yourself to prevent static charge when installing the internal components. Use a grounding wrist strap and place all electronic components in any static-shielded devices. Most electronic components are sensitive to static electrical charge.
3. Disconnect the power cord from the **rBOX101-FL** before making any installation. Be sure both the system and the external devices are turned OFF. Sudden surge of power could ruin sensitive components. Make sure the **rBOX101-FL** is properly grounded.
4. Make sure the voltage of the power source is correct before connecting the equipment to the power outlet.
5. Turn OFF the system power before cleaning. Clean the system using a cloth only. Do not spray any liquid cleaner directly onto the screen.
6. Do not leave this equipment in an uncontrolled environment where the storage temperature is below -45 or above 85 . It may damage the equipment.
7. Do not open the system's back cover. If opening the cover for maintenance is a must, only a trained technician is allowed to do so. Integrated circuits on computer boards are sensitive to static electricity. To avoid damaging chips from electrostatic discharge, observe the following precautions:
  - Before handling a board or integrated circuit, touch an unpainted portion of the system unit chassis for a few seconds. This will help to discharge any static electricity on your body.
  - When handling boards and components, wear a wrist-grounding strap, available from most electronic component stores.

## Classification

1. Degree of protection against electric shock: not classified
2. Degree of protection against the ingress of water: IP30
3. Equipment not suitable for use in the presence of a flammable anesthetic mixture with air or with oxygen or nitrous oxide.
4. Mode of operation: Continuous
5. Type of protection against electric shock: Class I equipment

## General Cleaning Tips

You may need the following precautions before you begin to clean the computer. When you clean any single part or component for the computer, please read and understand the details below fully.

When you need to clean the device, please rub it with a piece of dry cloth.

1. Be cautious of the tiny removable components when you use a vacuum cleaner to absorb the dirt on the floor.
2. Turn the system off before you start to clean up the component or computer.
3. Never drop the components inside the computer or get circuit board damp or wet.
4. Be cautious of all kinds of cleaning solvents or chemicals when you use it for the sake of cleaning. Some individuals may be allergic to the ingredients.
5. Try not to put any food, drink or cigarette around the computer.

### Cleaning Tools:

Although many companies have created products to help improve the process of cleaning your computer and peripherals users can also use household items to clean their computers and peripherals. Below is a listing of items you may need or want to use while cleaning your computer or computer peripherals.

Keep in mind that some components in your computer may only be able to be cleaned using a product designed for cleaning that component, if this is the case it will be mentioned in the cleaning.

- Cloth: A piece of cloth is the best tool to use when rubbing up a component. Although paper towels or tissues can be used

on most hardware as well, we still recommend you to rub it with a piece of cloth.

- Water or rubbing alcohol: You may moisten a piece of cloth a bit with some water or rubbing alcohol and rub it on the computer. Unknown solvents may be harmful to the plastics parts.
- Vacuum cleaner: Absorb the dust, dirt, hair, cigarette particles, and other particles out of a computer can be one of the best methods of cleaning a computer. Over time these items can restrict the airflow in a computer and cause circuitry to corrode.
- Cotton swabs: Cotton swabs moistened with rubbing alcohol or water are excellent tools for wiping hard to reach areas in your keyboard, mouse, and other locations.
- Foam swabs: Whenever possible it is better to use lint free swabs such as foam swabs.



**Note** *We strongly recommended that you should shut down the system before you start to clean any single components.*

**Please follow the steps below:**

1. Close all application programs
2. Close operating software
3. Turn off power switch
4. Remove all device
5. Pull out power cable

## **Scrap Computer Recycling**

If the computer equipments need the maintenance or are beyond repair, we strongly recommended that you should inform your AXIOMTEK distributor as soon as possible for the suitable solution. For the computers that are no longer useful or no longer working well, please contact your AXIOMTEK distributor for recycling and we will make the proper arrangement.

## **Trademarks Acknowledgments**

AXIOMTEK is a trademark of AXIOMTEK Co., Ltd.

IBM, PC/AT, PS/2, VGA are trademarks of International Business Machines Corporation.

Intel<sup>®</sup> and Pentium<sup>®</sup> are registered trademarks of Intel Corporation.

MS-DOS, Microsoft C and QuickBASIC are trademarks of Microsoft Corporation.

VIA is a trademark of VIA Technologies, Inc.

SST is a trademark of Silicon Storage Technology, Inc.

UMC is a trademark of United Microelectronics Corporation.

Other brand names and trademarks are the properties and registered brands of their respective owners.

## Table of Contents

Disclaimers.....	ii
Safety Precautions .....	iii
Classification .....	iv
General Cleaning Tips.....	iv
Scrap Computer Recycling.....	vi
<b>CHAPTER 1.....</b>	<b>1</b>
<b>INTRODUCTION .....</b>	<b>1</b>
1.1    General Description.....	1
1.2    System Specifications.....	3
1.3    Dimensions .....	20
1.4    I/O Outlets.....	22
1.5    Packing List.....	26
<b>CHAPTER 2.....</b>	<b>27</b>
<b>HARDWARE INSTALLATION .....</b>	<b>27</b>
2.1    Installing the Memory Module .....	27
2.2    Installing the CompactFlash™ Card .....	31
2.3.1  Installing Din-rail Mounting .....	37
2.3.2  Setting up rBOX by Din-rail mounting .....	42
2.4    Installing Wall Mounting (optional).....	45
<b>CHAPTER 3.....</b>	<b>49</b>
<b>PHOENIX-AWARD BIOS UTILITY.....</b>	<b>49</b>
3.1    Entering Setup .....	49
3.2    Control Keys .....	50
3.3    Getting Help .....	51
3.4    The Main Menu.....	52
3.5    Standard CMOS Setup Menu .....	53
3.6    Advanced BIOS Features.....	55
3.7    Advanced Chipset Features .....	64
3.8    Integrated Peripherals.....	67
3.9    Power Management Setup.....	76

3.10	PnP/PCI Configuration Setup .....	77
3.11	PC Health Status.....	83
3.12	Load Optimized Defaults.....	84
3.13	Set Supervisor/User Password .....	85
3.14	Save & Exit Setup .....	87
3.15	Exit Without Saving .....	88
<b>CHAPTER 4</b>	.....	<b>89</b>
4.1	INSTALLATION OF LAN DRIVER UPDATE.....	89
4.2	NOTICE FOR INSTALLATION OF DRIVER.....	101
<i>MEMO</i>	.....	<b>102</b>



***MEMO***



# CHAPTER 1

## INTRODUCTION

This chapter contains general information and detailed specifications of the **rBOX101-FL**. The Chapter 1 includes the following sections:

- **General Description**
- **System Specification**
- **Dimensions**
- **I/O Outlets**
- **Package List**

### 1.1 General Description

The **rBOX101-FL** Din-rail fanless embedded systems are suitable for communications control and for protocol converter applications in critical environments. Built for rugged work environments, the **rBOX101-FL** series features an extra low power consumption Intel<sup>®</sup> ATOM<sup>™</sup> Z510PT (1.1 GHz) or Z520PT (1.33 GHz) processors supporting industrial temperature range of -40 to +70 . Their front accessible I/O cabling is very convenient for wiring and maintenance. The **rBOX101-FL** series offers a VGA output, making it particularly well-suited for communication control, SCADA and industrial automation. Its compact size with Din-rail mounting allows for easy installation into control cabinet. Pre-installed with Linux, Windows<sup>®</sup> CE 6.0, Windows<sup>®</sup> 7 embedded or Windows<sup>®</sup> XP embedded, the **rBOX101-FL** series provides programmers with a friendly environment for developing application software at a lower cost.

The **rBOX101-FL** is robust industrial-grade hardware design and adopts the advanced cooling system, besides, supporting the CompactFlash<sup>™</sup>, which makes it especially suitable for field control & monitoring system solution for following markets:

- Utility Industries (Water; Energy; Chemical Plant; Mining...)
- Public Transportation Industries (Traffic/ Highway

Control; Train/Bus Control ...)  
Homeland Security (Weather Monitoring/Alarm  
System ...)

➤ **Features**

1. Fanless and no internal cabling design
2. Wide temperature operation of -40 - +70
3. 1 isolated DIO (4 IN/OUT) for rBOX101-6COM
4. Supports 2 Ethernets with Magnetic Isolation Protection
5. 2 Watchdog Timers
6. LED Indicators (Power, Alarm, Ready/Active, COM (TXD,RXD) )
7. Wireless (Optional by ODM order)
8. SNMP V1/V2c
9. Support one CompactFlash™
10. 2 power paths with terminal block and 12–48VDC
11. Din-rail mounting
12. Wall mounting (optional)
13. Meet safety agency requirements (UL508, UL60950) & passed heavy industrial EMI/EMS testing (ex: EN61000-6-4, EN61000-6-2 ...)

➤ **Embedded O.S. Supported**

The **rBOX101-FL** not only supports Windows® XP, but also supports embedded OS, such as Windows® XP embedded, Windows® 7 embedded, Windows® CE 6.0 and Linux. For storage device, the **rBOX101-FL** supports one type II CompactFlash™ slot.

## **1.2 System Specifications**

### **1.2.1 CPU**

- Onboard Intel® ATOM™ Z510PT (1.1 GHz) or Z520PT (1.33 GHz) processors with FSB 400/533MHz.

### **1.2.2 Chipset**

- Intel System Controller Hub US15WPT

### **1.2.3 BIOS**

- Phoenix AwardBIOS

### **1.2.4 System Memory**

- One 200-pin SO-DIMM support DDR2 400/533MHz max. up to 2GB

### **1.2.5 Graphics Chip**

- Intel GMA500 graphics Core integrate in US15W PT
- DB15 VGA port

### **1.2.6 Video Memory**

- Share Memory max. up to 256MB.

### **1.2.7 LAN**

- LAN 1 :
  - . GBE Intel 82574, 10/100/1000Mbps LAN w/ Magnetic Isolation Protection 1.5KV
  - . LED definition: Active LED (Yellow flashing), 10 LAN LED (NO Light), 100 LAN LED (Green Light), 1000 LAN LED (Orange Light)
  
- LAN 2 :
  - . FE Davicom DM9102HI, 10/100Mbps LAN w/ Magnetic Isolation Protection 1.5KV
  - . LED definition: Active LED (Yellow flashing), 10 LAN LED (NO Light), 100 LAN LED (Green Light)

### **1.2.8 Storage**

- 1 x CompactFlash Typell

### **1.2.9 USB**

- 2 x USB2.0
- With power distribution control and over current protection

### **1.2.10 COM**

- 2 ports DB9 Pin Define RS-232/422/485
- ESD Protection 15KV
- Magnetic Isolation Protection 2KV
- The interface select by software or BIOS.
- It also supports Auto Flow Control in RS485 mode
- COM1,COM2 speed up to 115.2kbps
- COM3-COM4 Serial Port Speed up to 921.6kbps (rBOX101-4COM)  
COM3-COM6 Serial Port Speed up to 921.6kbps (rBOX101-6COM)

### 1.2.11 Power

- 2 power paths
- 2 power sources must be same voltage and DC input range 12-48V.
- Main power source is for Input Power Path 1, Backup power source is for Input Power Path 2.
- Only one power source must be for Input Power Path 1.
- DC Input has UVP/OVP/Reverse protection.
- Reset Button without Power Switch



**NOTE** *If 2 power sources aren't same voltage and the system will be possible damage.*



**NOTE** *When the system is shutdown after, if users press the **Reset Button** for **3 seconds** and the system will be restarted.*

### **1.2.12 Watch Dog Timer (WDT)**

- 2 WDT
- WDT 1 : one step is 1sec, 255 levels  
WDT 2 : one step is 250ms, 255 levels

### **1.2.13 Digital I/O Connector and Pin Definition**

- 4bit DI and 4bit DO
- DI :  
Input range : 0~24 VDC  
Logic level 0 : +/- 3V max.  
Logic level 1 : +/- 5V min. (DI to COM-)  
3KV optical isolation  
Support Dry Contact or Wet Contact
- DO :  
Max. 200 mA per channel, current sink type  
24VDC nominal, open collector to 30V  
3KV optical isolation



■ DIO 4 in/out of TB10 Female

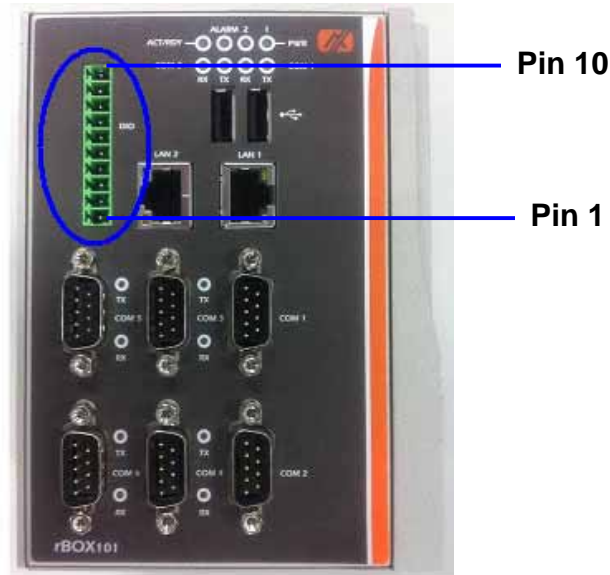

TB10 Pin No .	Signal name	Meaning
1	XCOM+	Plus Common for DIO
2	D10	
3	D11	
4	D12	
5	D13	
6	DO0	
7	DO1	
8	DO2	
9	DO3	
10	XCOM-	Minus Common for DIO

**DIO Control**

<b>Jumper</b>	<b>DI &amp; DO State</b>	<b>Operation</b>
<b>1-2 (Default) DRY</b>	DI to COM -	Internal power 5V for DI, DI to COM-, Photocoupler is active low
<b>1-2 (Default) WET</b>	DI to COM -	External power 0~24V, DI to COM-, Photocoupler is active low
<b>2-3 WET</b>	External power 0~24V to DI	Each DI port connector to independent external power input 0~24V, Photocoupler is active low
/	COM+ to DO	Load connector Do port to COM+ Logic level 1 : LAOD is enable Logic level 0 : LOAD is disable

Reference 1.

### Digital Input Connectivity

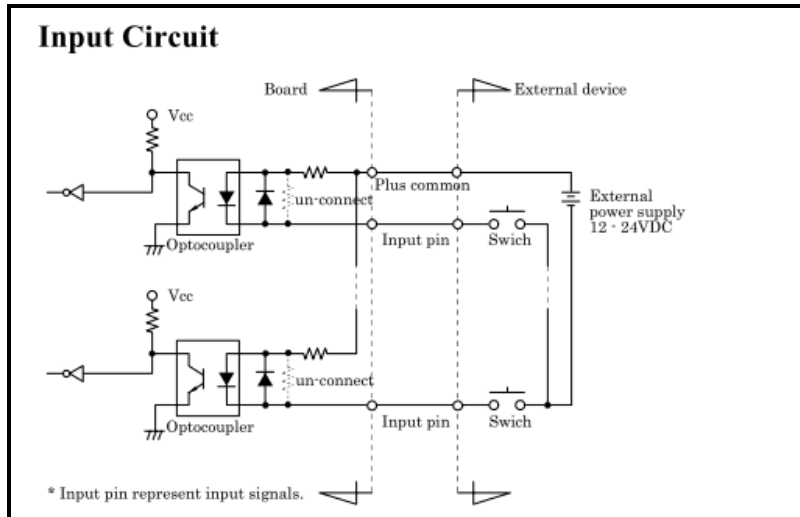

Reference 2.

### Digital Output Connectivity

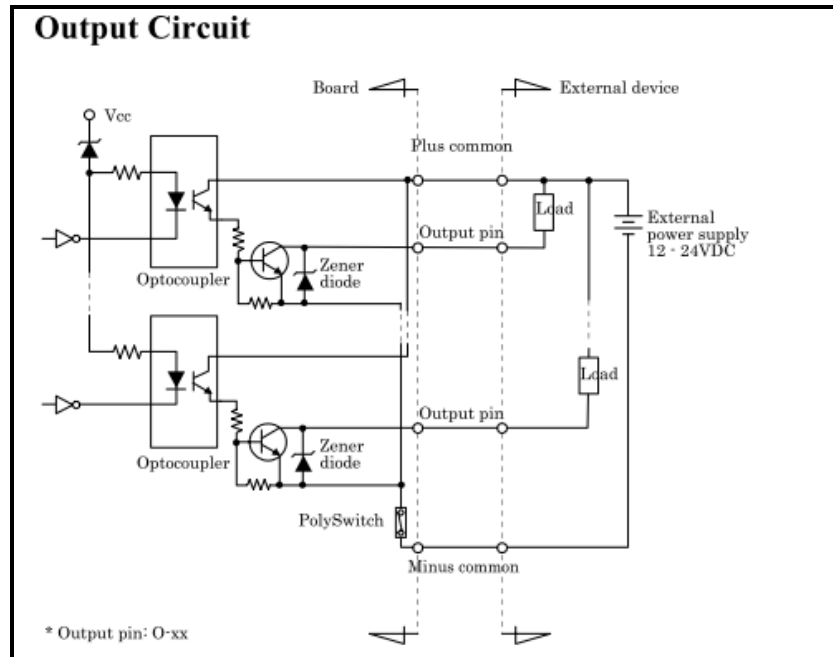

Reference 3

### Digital Input Wiring

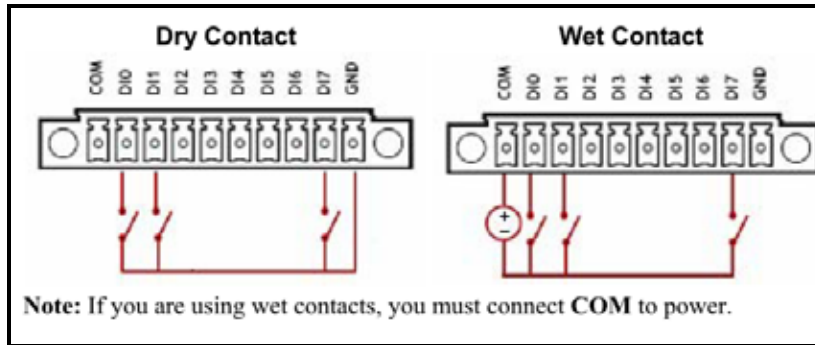

Reference 4

### Digital Output Wiring

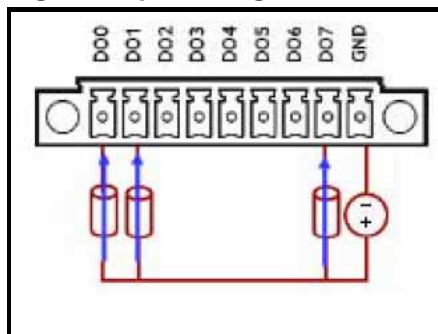

### 1.2.14 System LED

For maintenance issue, IO board will have below LED.

1. DC PWR1 : Green
2. DC PWR2 : Green
3. Alarm : Red
4. OS Ready : Yellow
5. COM TX1 : Green
6. COM RX1 : Green
7. COM TX2 : Green
8. COM RX2 : Green

LED Name	Description	Color	Note
DC PWR1	Indicate the DC1 input status. When the DC input is acceptable, the LED will ON.	Green	
DC PWR2	Indicate the DC2 input status. When the DC input is acceptable, the LED will ON.	Green	
Alarm	The LED will ON if having below condition. 1. DC PWR1 or PWR2 is lost. (default) 2. User define event.(option) The behavior of Alarm and Relay are the same. When the LED of Alarm is ON and the Relay will be turn on at the same time.	Red	
RDY/ACT	The LED for RDY/ACT can help users to judge BIOS finish or not and the OS can normal work or not.  When the BIOS finish the configuration of system, the LED will ON. After this the LED will flash when the storage is accessed.  - The LED will flash when the storage is accessed.	Yellow	

	<ul style="list-style-type: none"> <li>- The LED always ON without any flash for a long time, the OS is possible crashed.</li> <li>- The LED isn't ON for a long time, it means the system is on shutdown status.</li> </ul>		
COM TX1	When COM1 transmit data the LED will on.	Green	
COM RX1	When COM1 receive data the LED will on.	Green	
COM TX2	When COM2 transmit data the LED will on.	Green	
COM RX2	When COM2 receive data the LED will on.	Green	



**NOTE** When the system is shutdown after, if users press the **Reset Button** for **3 seconds** and the system will be restarted.

**Below pictures are the LED example:**



Indicate the PWR1 input status.  
When the DC input is acceptable, the LED will ON.





The LED will ON if having below condition.  
1. DC PWR1 or PWR2 is lost. (default)  
2. User define event. (option)  
The behavior of Alarm and Relay are the same.  
When the LED of Alarm is ON and the Relay will be turn on at the same time.



Because the PWR1 is still linked, so, the LED of PWR1 is still ON.

When the system is shut down, the LED of ACT/RDY will not ON.



When the BIOS finish the configuration of system, the LED of ACT/RDY will ON.  
After the LED of ACT/RDY will flash when the storage is accessed.

#### 1.2.15 Alarm Contact

- 1 relay output
- Relay output with 0.5A @ 30VDC
- Event : Power Fail and User define

#### 1.2.16 Wireless (Optional by ODM order)

- 1 x Mini Card ( Support USB only)
- 1 x SIM Socket on board

#### 1.2.17 Reset Bottom

- 1 x Reset bottom



**NOTE** When the system is shutdown after, if users press the **Reset Button** for **3 seconds** and the system will be restarted.

#### 1.2.18 Operation Temperature

- -40 ~ +70 (-40 °F ~ +158°F), with W.T. (Memory & CF)

#### 1.2.19 Storage Temperature

- -45 ~ +85 (-49 °F ~ +185°F)

#### 1.2.20 Humidity

- 5% ~ 95% (non-condensation)

#### 1.2.21 Weight

- 1.38 kg (3 lb) for rBOX101-4COM

### **1.2.22 Dimensions**

- 81mm(3.18") (W) x110mm(4.33") (D) x135mm(5.31") (H)  
for rBOX101-4COM
- 100.6mm(3.96") (W) x110mm(4.33") (D) x135mm(5.31") (H)  
for rBOX101-6COM

### **1.2.23 System I/O Outlet**

- 6 (or 4) 9-pin D-Sub male connectors, COM1~COM6 (rBOX101-6COM) or COM1~COM4 (rBOX101-4COM) for RS-232/422/485
- One 15-pin D-Sub female connector for VGA
- One 10/100/1000Mbps Ethernet with Magnetic Isolation Protection & one 10/100Mbps Ethernet with Magnetic Isolation Protection
- Two USB 2.0 connectors
- One isolated DIO (4 IN/OUT) for (rBOX101-6COM)
- Two DC Powers Input with terminal block
- Alarm Contact
- Wireless (Optional by ODM order)



**NOTE** *All specifications and images are subject to change without notice.*

### 1.3 Dimensions

The following diagrams show you dimensions and outlines of the **rBOX101-6COM-FL** and **rRBOX101-4COM-FL**.

■ rBOX101-6COM-FL

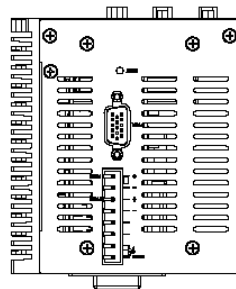
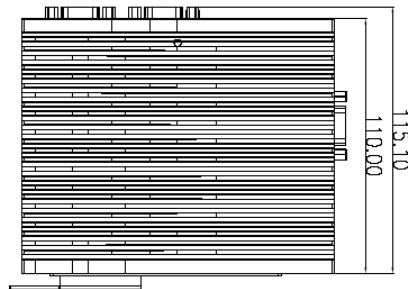
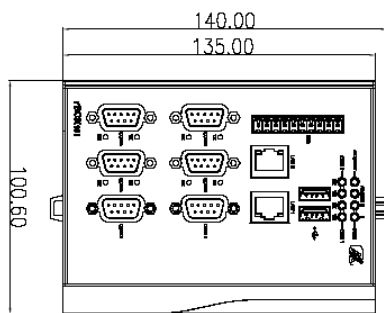

■ rRBOX101-4COM-FL

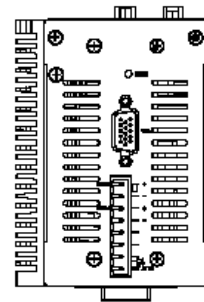
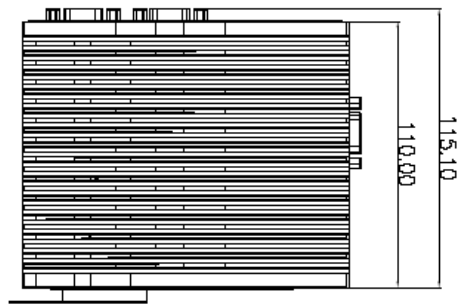
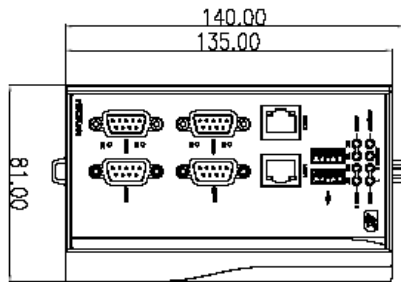

## 1.4 I/O Outlets

The following figures show you I/O outlets on front view and top view of the rBOX101-6COM-FL and rBOX101-4COM.

- Front View

rBOX101-6COM-FL

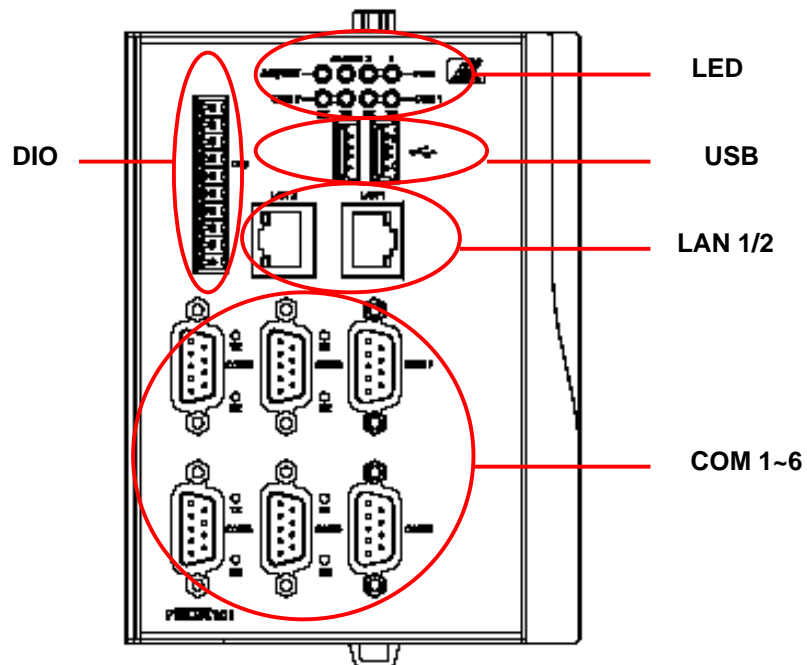



rBOX101-4COM

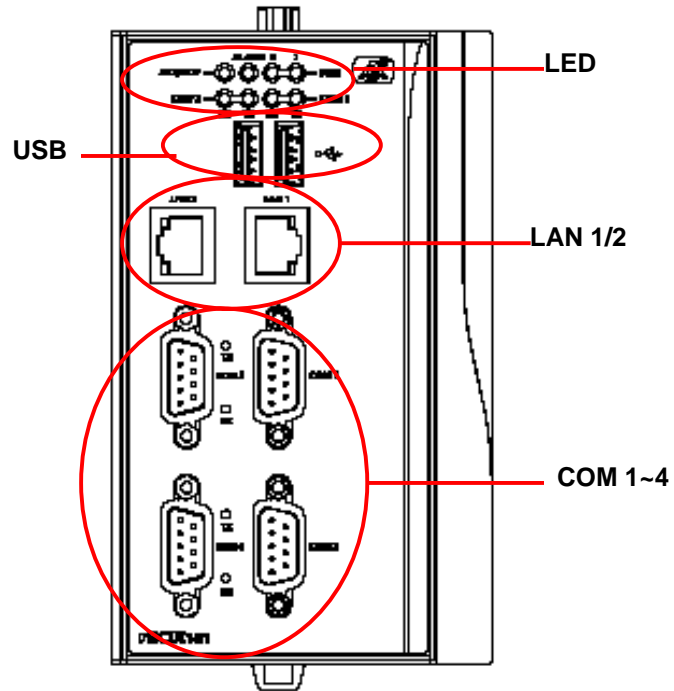

- Top View

rBOX101-6COM-FL

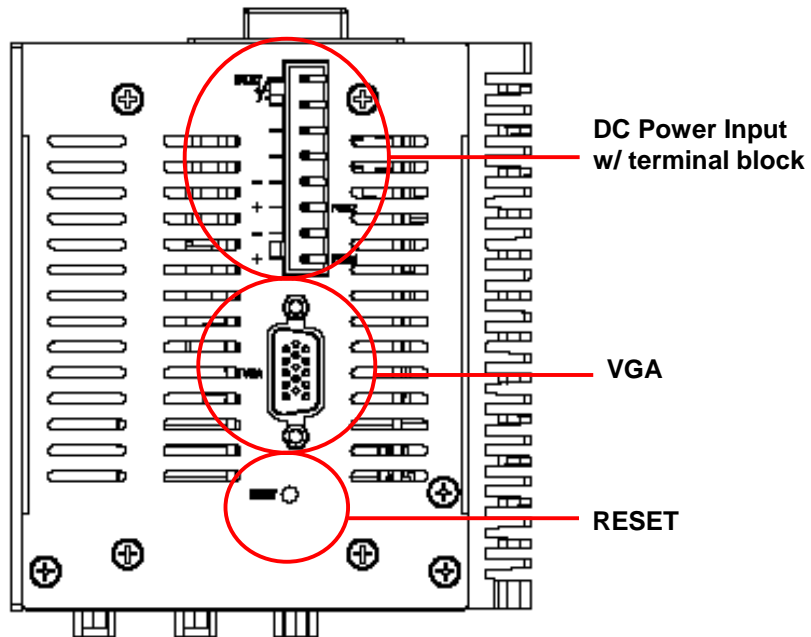

rBOX101-4COM

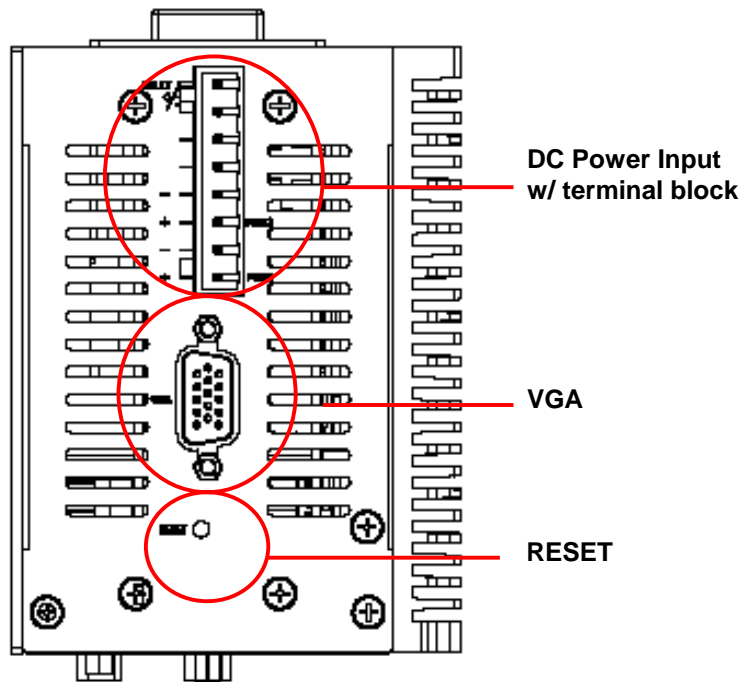

## **1.5 Packing List**

The package bundled with your **rBOX101-FL** should contain the following items:

- rBOX101-FL System Unit x 1
- CD x 1 (For Driver and User's Manual)
- Power terminal block x1
- DIO female connector x1 (rBOX101-6COM)
- Din-rail kit x1
- Screws
- Quick Manual x1

## CHAPTER 2 HARDWARE INSTALLATION

The rBOX101-FL is convenient for your various hardware configurations, such as Memory Module and CompactFlash™ card. The chapter 2 will show you how to install the hardware. It includes:

### 2.1 Installing the Memory Module

- Step 1** Turn off the system.
- Step 2** Loosen these screws, and remove the top cover from the system.



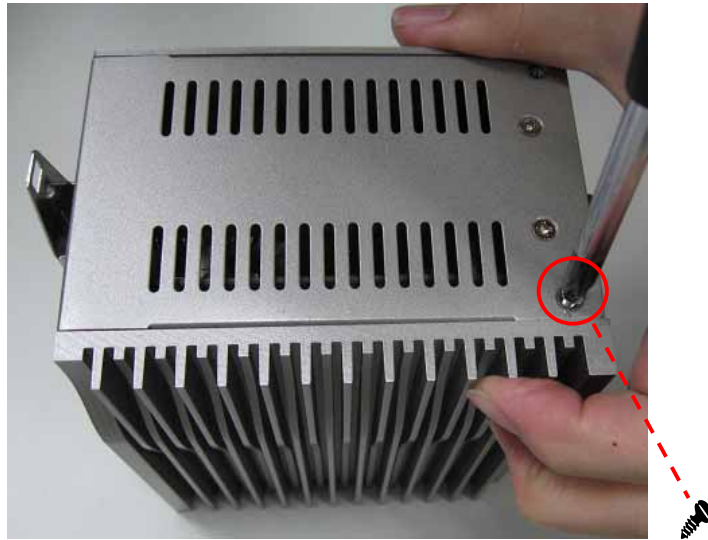

**Step 3** Hold one side of the module, and insert the gold colored contact into the socket. Push the module down.

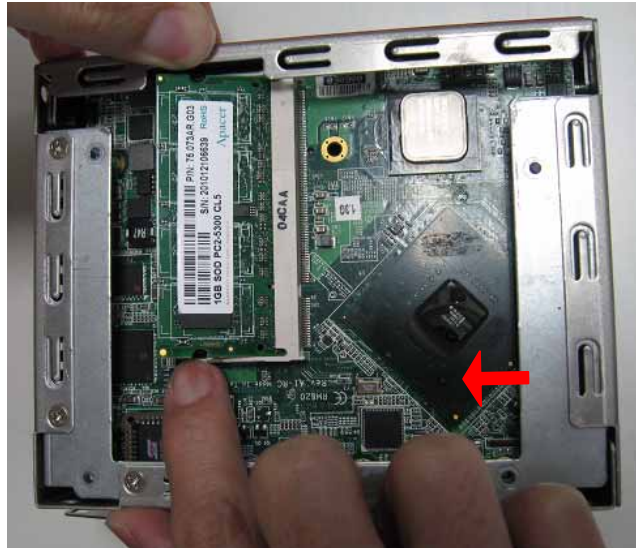

**Step 4** The memory module is locked by two latches on the sides.



- Step 5** Put the cover back to the system, and fasten screws tight close the chassis.





## 2.2 Installing the CompactFlash™ Card

- Step 1** Turn off the system.
- Step 2** Loosen these screws, and remove the cover from the system.





Step 3 Locate the CompactFlash™ socket.



- Step 4** Loosen these screws and remove the CompactFlash™ fixing bracket.

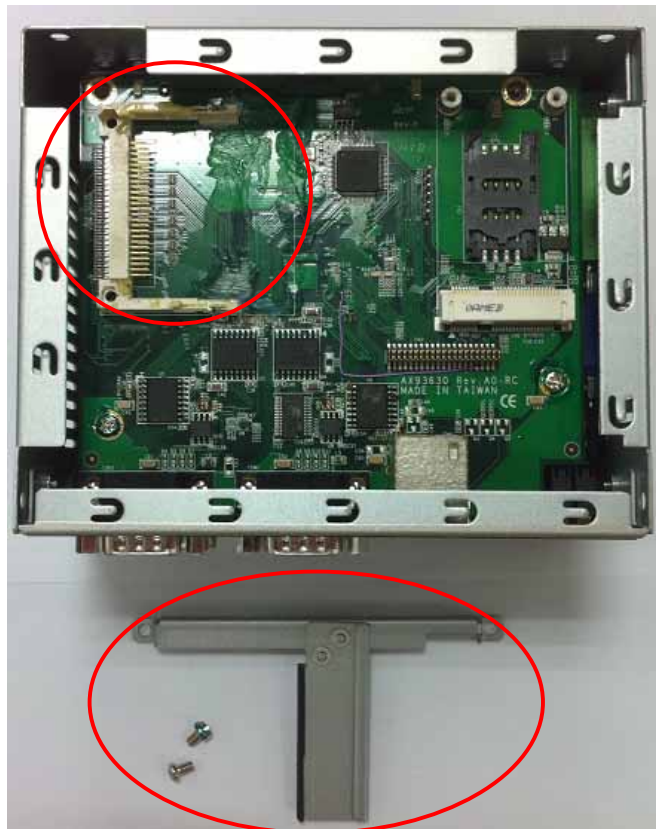

- Step 5** Insert the CompactFlash™ card into the socket until it is firmly seated.



**Step 6** Put the CompactFlash™ fixing bracket back to the system, and fasten screws tight close the CompactFlash™ fixing bracket .



**Step 7** Put the cover back to the system, and fasten screws tight close the chassis.



### **2.3.1 Installing Din-rail Mounting**

The **rBOX101-FL** provides Din-rail Mount that customers can install as below:

- Step 1** Prepare DIN Mount assembling components (screws and bracket) ready.



**Step 2** Assembly the bracket to the system, and fasten screws tight.





 **NOTE** Please notice the Din-rail holes with Wall-mounting holes while assembly the bracket to system.

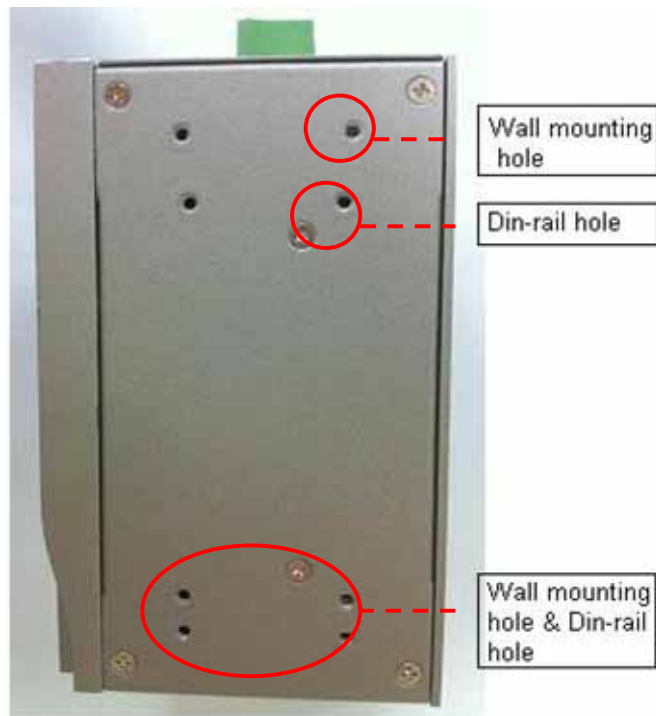





**NOTE** The Din-rail kit drawing is listed below:

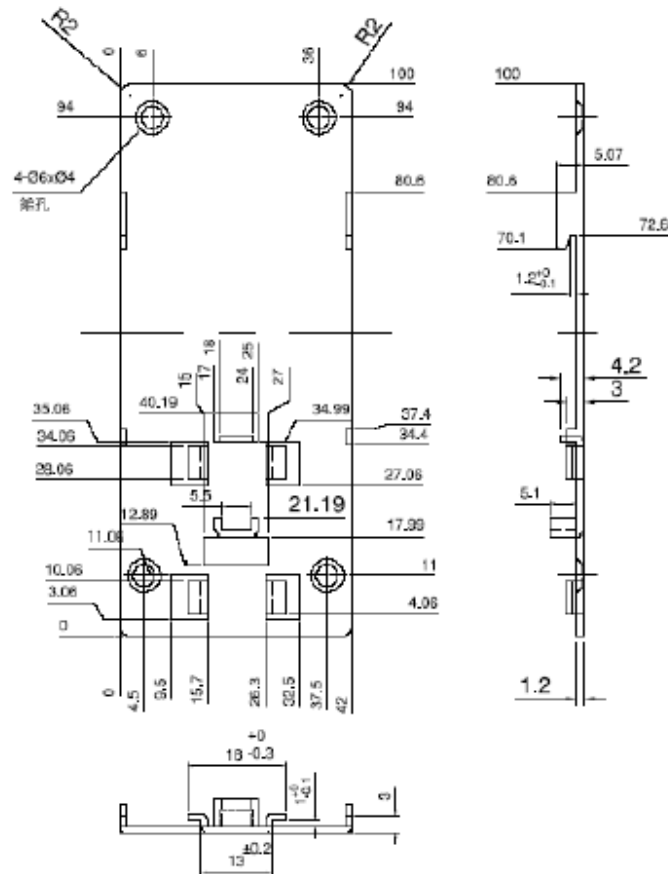

### **2.3.2 Setting up rBOX by Din-rail mounting**

The **rBOX101-FL** set up by Din-rail mounting as below:

**Step 1** Fixing the rail firstly.



**Step 2** Set up the rBOX101-FL on the rail by Din-rail mounting





## **2.4 Installing Wall Mounting (optional)**

The **rBOX101-FL** provides Wall Mounting that customers can install as below:

- Step 1** Prepare Wall Mount assembling components (screws and bracket) ready.



**Step 2** Assembly the bracket to the system, and fasten screws tight.

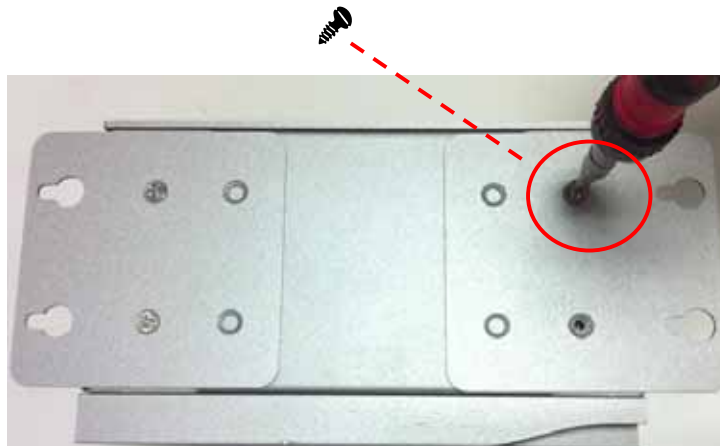





 **NOTE** Please notice the Din-rail holes with Wall-mounting holes while assembly the bracket to system.



## **CHAPTER 3**

### **PHOENIX-AWARD BIOS UTILITY**

The Phoenix-Award BIOS provides users with a built-in Setup program to modify basic system configuration. All configured parameters are stored in a flash-backed-up to save the Setup information whenever the power is turned off.

#### **3.1 Entering Setup**

There is one way to enter the Setup program. You may either turn ON the computer and press <Del> immediately.

### **3.2 Control Keys**

Up arrow	Move to the previous item
Down arrow	Move to the next item
Left arrow	Move to the left side
Right arrow	Move to the right side
Esc key	Main Menu -- Quit and delete changes into CMOS Status Page Setup Menu and Option Page Setup Menu -- Exit current page and return to Main Menu
PgUp/“+”key	Increase the numeric value or make changes
PgDn/“-“ key	Decrease the numeric value or make changes
F6 key	Load the default CMOS value from BIOS default table, only for Option Page Setup Menu
F7 key	Load the Setup default, only for Option Page Setup Menu
F10 key	Save all the CMOS changes, only for Main Menu

### **3.3 Getting Help**

**Main Menu** The online description of the highlighted setup function is displayed at the bottom of the screen.

**Status Page Setup Menu/Option Page Setup Menu** Press <F1> to pop out a General Help Window that provides the description of using appropriate keys and possible selections for highlighted items. Press <Esc> to exit the Help Window.

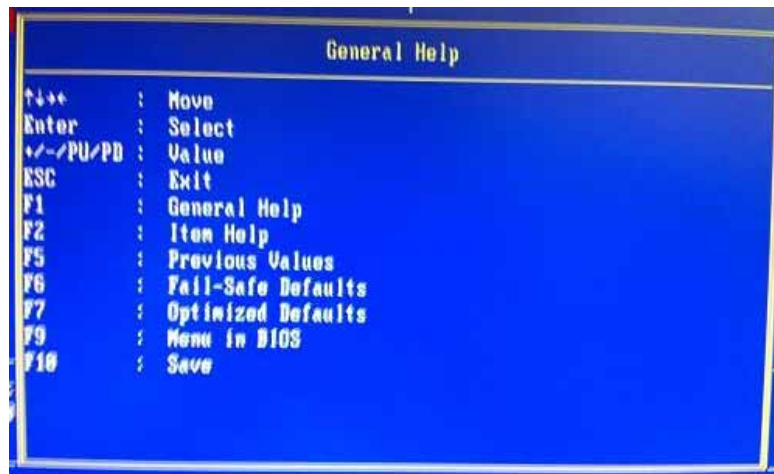

### 3.4 The Main Menu

Once you enter the Award BIOS CMOS Setup Utility, the Main Menu appears on the screen. In the Main Menu, there are several Setup functions and a couple of Exit options for your selection. Use arrow keys to select the Setup Page you intend to configure then press <Enter> to accept or enter its sub-menu.



 **NOTE** If your computer can not boot after making and saving system changes with Setup, the Award BIOS will reset your system to the CMOS default settings via its built-in override feature.

 **NOTE** It is strongly recommended that you should avoid changing the chipset's defaults. Both Award and your system manufacturer have carefully set up these defaults that provide the best performance and reliability.

### 3.5 Standard CMOS Setup Menu

The Standard CMOS Setup Menu displays basic information about your system. Use arrow keys to highlight each item, and use <PgUp> or <PgDn> key to select the value you want in each item.



- **Date**  
The date format is <day> <month> <date> <year>.
- **Time**  
This item shows current time of your system with the format <hour> <minute> <second>. The time is calculated based on the 24-hour military-time clock. For example, 1 p.m. is 13:00:00.

 **NOTE** If system is power failure, the date and time will come back to previous setup.

- **IDE Primary Master/Primary Slave**

These items identify the types of each IDE channel installed in the computer, so, IDE type is auto detection.

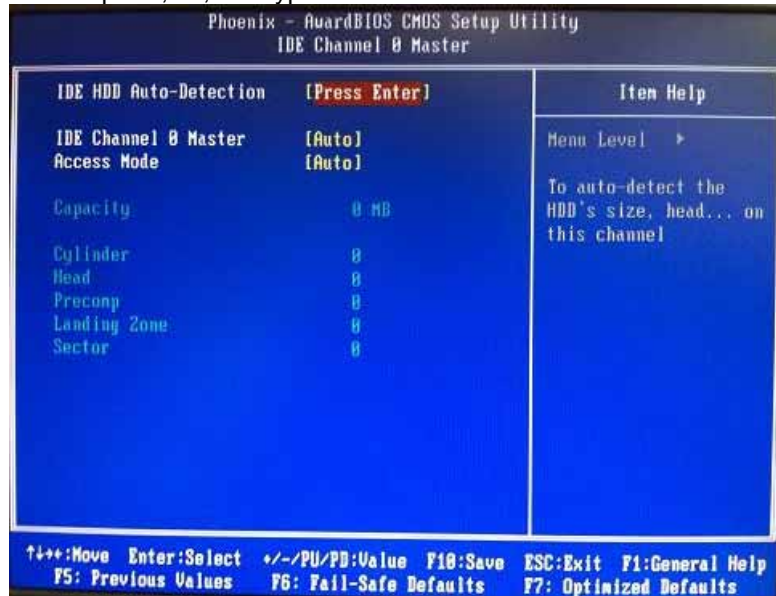

- **Video**

Select the display adapter type for your system.

- **Halt On**

This item determines whether the system will halt or not, if an error is detected while powering up.

<b>No errors</b>	The system booting will halt on any errors detected. (default)
<b>All errors</b>	Whenever BIOS detects a non-fatal error, the system will stop and you will be prompted.
<b>All, But Keyboard</b>	The system booting will not stop for a keyboard error; it will stop for other errors.

- Press <Esc> to return to the Main Menu page. USB Device Setting





 **NOTE** The BIOS default setting of the system is “**Previous Setup**”. It means that if the system is power failure or power loss, the system will come back to previous setup while be re-boot.

If you want to change the BIOS setting, please set up from “**Advanced BIOS Features**” (Please refer below graphic.)

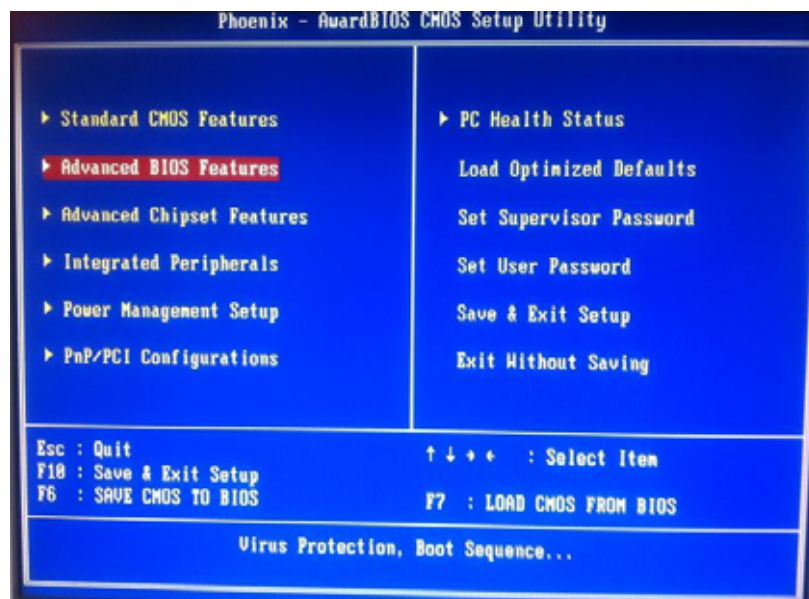

Then, to select **“BIOS Optimized”** or **“Previous Setup”** under **“Optimized Default Select”**. (Please refer below graphic.)

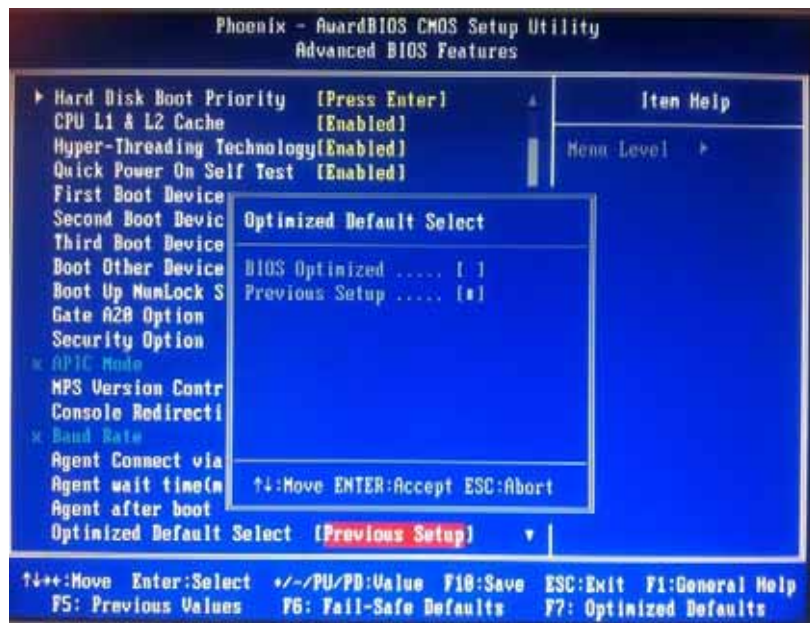

Further to save the selection (**System will execute about 15 seconds**)

Finally, please **shut down** the system, then **re-boot** it, the system will come back to your changed **Optimized Default Select**.

- **CPU Features**

Scroll to this item and press <Enter> to view the CPU Feature sub menu.



- **Harddisk boot priority**

Scroll to this item and press <Enter> to view the sub menu to decide the disk boot priority



- **Quick Power On Self Test**

This option speeds up Power on Self Test (POST) after you turn on the system power. If set as Enabled, BIOS will shorten or skip some check items during POST. The default setting is "Enabled".

Enabled	Enable Quick POST
Disabled	Normal POST

- **First/Second/Third Boot Device**

These items let you select the 1st, 2nd, and 3rd devices that the system will search for during its boot-up sequence. There is a wide range of options for your selection.

- **Boot Other Device**

This item allows the user to enable/disable the boot device not listed on the First/Second/Third boot devices option above. The default setting is "Enabled".

- **Boot Up NumLock Status**

Set the the Num Lock status when the system is powered on. The default value is "On".

- **Security Option**

This item allows you to limit access to the system and Setup, or just to Setup. The default value is "Setup".

System
Setup

**System** System requires correct password before booting, and also before permitting access to the Setup page.

**Setup** System will boot, but requires correct password before permitting access to Setup. (Default value)

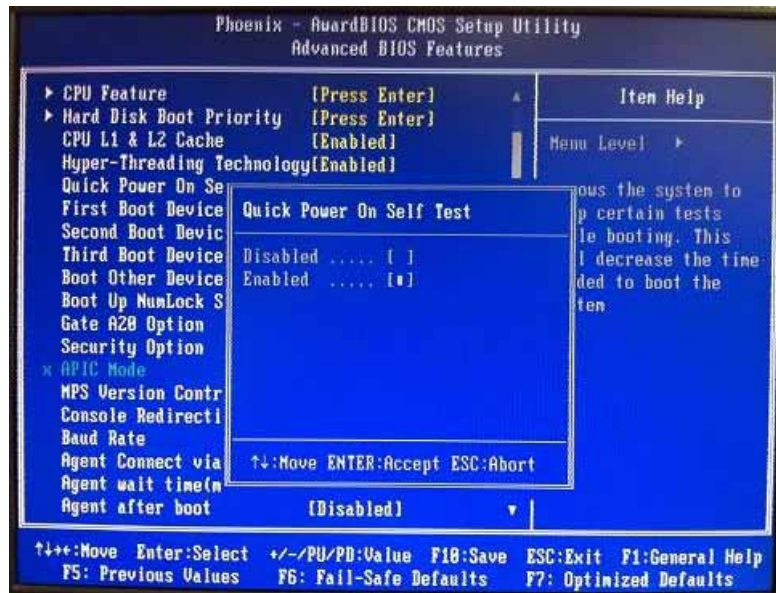

 **NOTE** To disable the security, select **PASSWORD SETTING** at Main Menu and then you will be asked to enter a password. Do not type anything, just press <Enter> and it will disable the security. Once the security is disabled, the system will boot and you can enter Setup freely.

- **APIC Mode**

APIC (Advanced Programmable Interrupt Controller) mode is *enabled* that provides symmetric multiprocessing (SMP) for systems.



 **NOTE** APIC Mode has been locked and cannot be modified.

- **MPS Version Control For OS**



This item specifies the version of the Multiprocessor Specification (MPS). Version 1.4 has extended configuration tables to improve support for multiple PCI bus configurations and provide future expandability.

Press <Esc> to return to the Main Menu page.



### 3.7 Advanced Chipset Features

This section contains completely optimized chipset's features on the board that you are strongly recommended to leave all items on this page at their default values unless you are very familiar with the technical specifications of your system hardware.



- **DRAM Timing Selectable**

Use this item to increase the timing of the memory. This is related to the cooling of memory.

- **System BIOS Cacheable**

Selecting Enabled allows caching of the system BIOS ROM at F0000h-FFFFFh, resulting in better system performance. However, if any program writes to this memory area, a system error may result. The default value is "Disabled".

- **Video BIOS Cacheable**

This item allows you to change the Video BIOS location from ROM to RAM. Video Shadow will increase the video speed.

\*\*\* VGA Setting \*\*\*

- **On-Chip Frame Buffer Size**

Use this item to set the VGA frame buffer size.

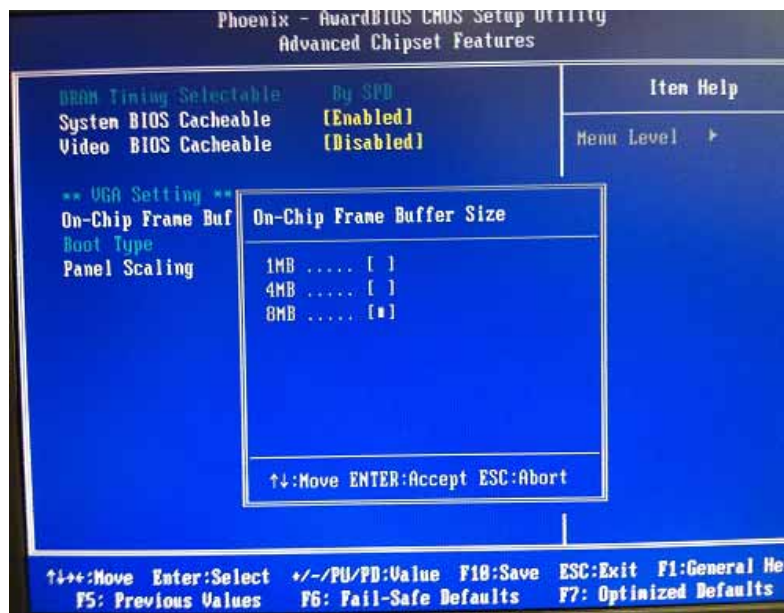

- **Boot Type (CRT Only)**

This item is to select Display Device that the screen will be shown. But its default is *CRT Only* and cannot be modified.

- **Panel Scaling (AUTO by default)**

This item shows the setting of panel scaling and operates the scaling function that the panel output can fit the screen resolution connected to the output port. Its default is *AUTO* and cannot be modified.

Press <Esc> to return to the Main Menu page.





- **OnChip IDE Device**

Scroll to this item and press <Enter> to view the sub menu OnChip IDE Device.

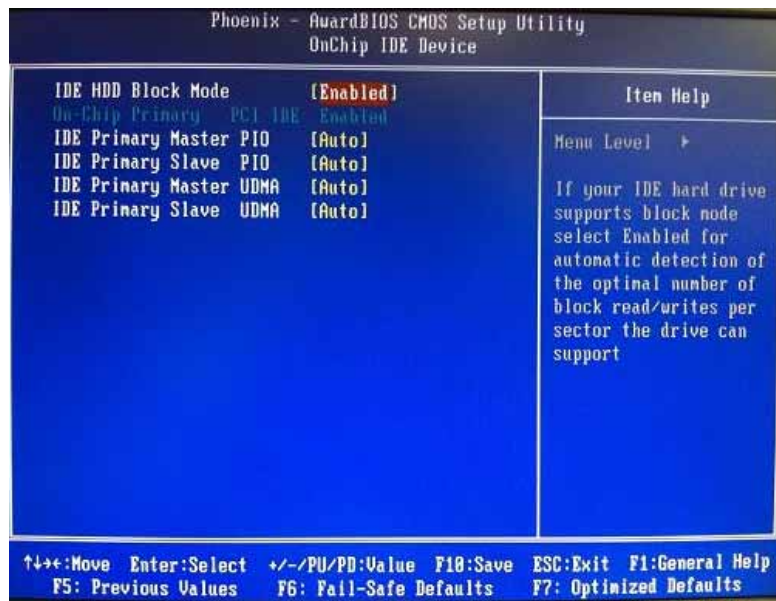

➤ **IDE HDD Block Mode**

Block mode is also called block transfer, multiple commands, or multiple sectors read/write. If your IDE hard drive supports block mode (most new drives do), select Enabled for automatic detection of the optimal number of block read/writes per sector the drive can support.

Press <Esc> to return to the Integrated Peripherals page.

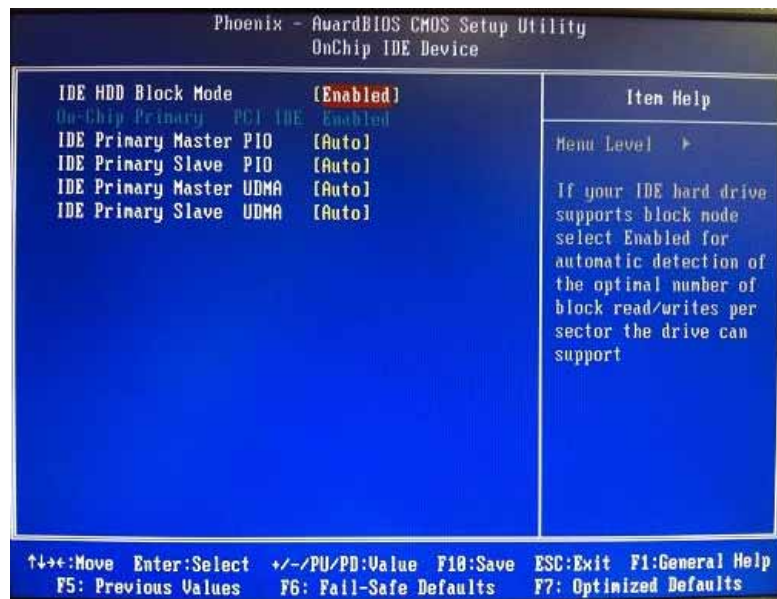



- **Onboard Device**

Scroll to this item and press <Enter> to view the sub menu Onboard Device.

- **Intel HD Audio Controller**

Choose Auto to *Disabled* an Intel HD Audio controller.



➤ **SDIO/MC Controller (Enabled)**

Choose *Enabled* on the SDIO/MMC Controller



Press <Esc> to return to the Integrated Peripherals page.

- COM Port Interface Type
  - **COM Port 1~6 (for rBOX101-6COM),**
  - **COM Port 1~4 (for rBOX101-4COM)**

The default setting for all COM Ports are RS232, you can change the default setting by selecting the value you want in each COM Port Type.

Press <ESC> to return to the Integrated Peripherals page.



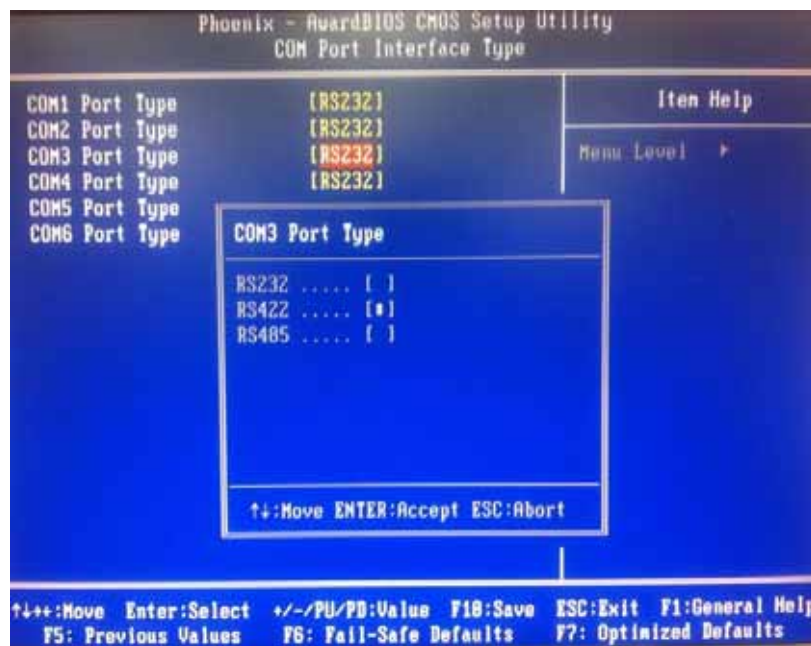
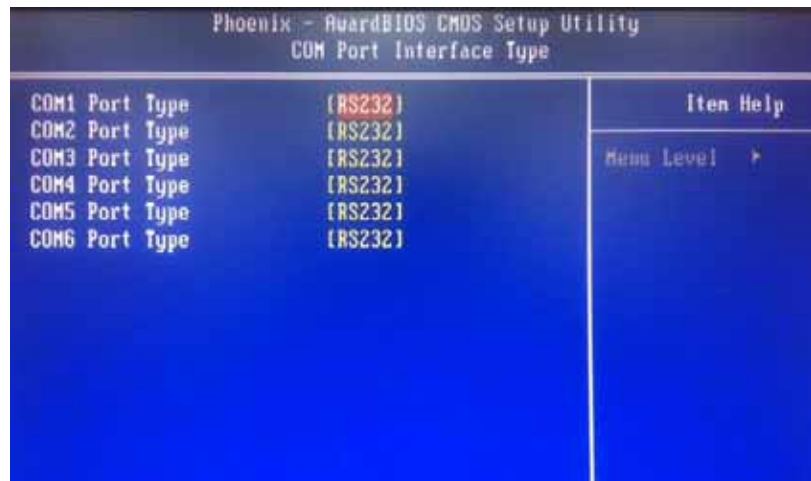

- **USB Device Setting**

Scroll to this item and press <Enter> to view the sub menu USB Device Setting.

Press <Esc> to return to the Integrated Peripherals page.



- **Onboard Lan Boot ROM**

Use this item to enable or disable the Boot ROM function of the onboard LAN chip when the system boots up. Its default is *disable*.

### **3.9 Power Management Setup**

The Power Management Setup allows you to save energy of your system effectively. It will shut down the hard disk and turn OFF video display after a period of inactivity.

- **ACPI Function**

Advanced Configuration and Power Management (ACPI).

The function is always “*Enabled*”.

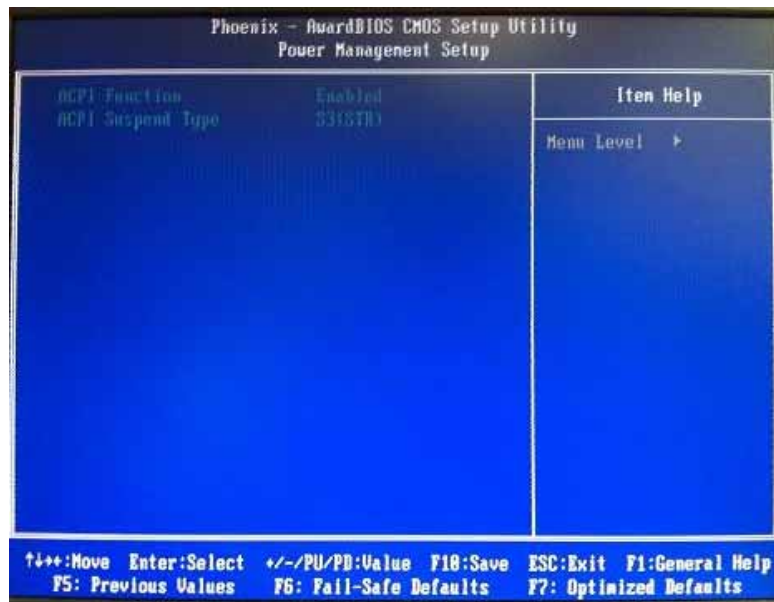

### 3.10 PnP/PCI Configuration Setup

This section describes the configuration of PCI (Personal Computer Interconnect) bus system, which allows I/O devices to operate at speeds close to the CPU speed while communicating with other important components. This section covers very technical items that only experienced users could change default settings.

- **Reset Configuration Data**

Normally, you leave this item Disabled. Select Enabled to reset Extended System Configuration Data (ESCD) when you exit Setup or if installing a new add-on cause the system reconfiguration a serious conflict that the operating system can not boot. Options: Enabled, Disabled.



● **Resources Controlled By**

The Award Plug and Play BIOS can automatically configure all boot and Plug and Play-compatible devices. If you select Auto, all interrupt request (IRQ), DMA assignment and Used DMA fields disappear as the BIOS automatically assigns them. The default value is "Auto". The other option is "Manual"

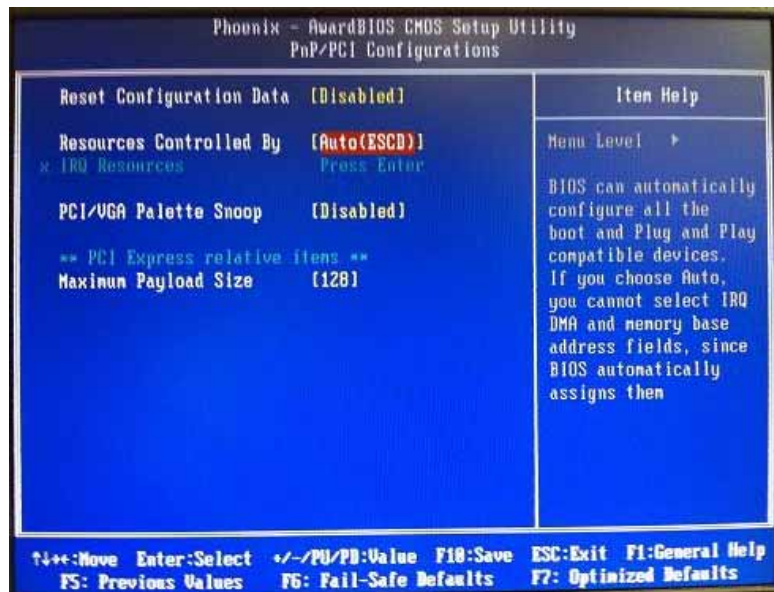



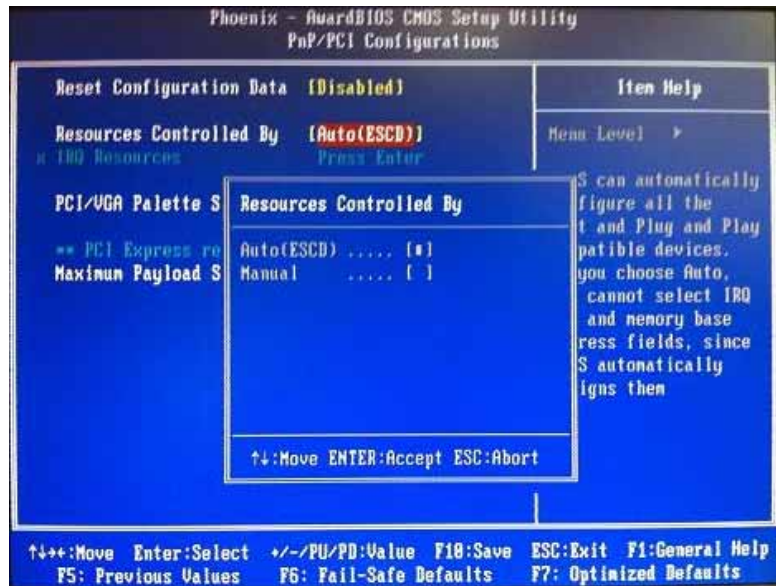

● **IRQ Resources**

When resources are controlled manually, assign each system interrupt to one of the following types in accordance with the type of devices using the interrupt:

1. Legacy ISA Devices compliant with the original PC AT bus specification, requiring a specific interrupt (such as IRQ4 for serial port 1).
2. PCI/ISA PnP Devices compliant with the Plug and Play standard,

whether designed for PCI or ISA bus architecture. The default value is "PCI/ISA PnP".

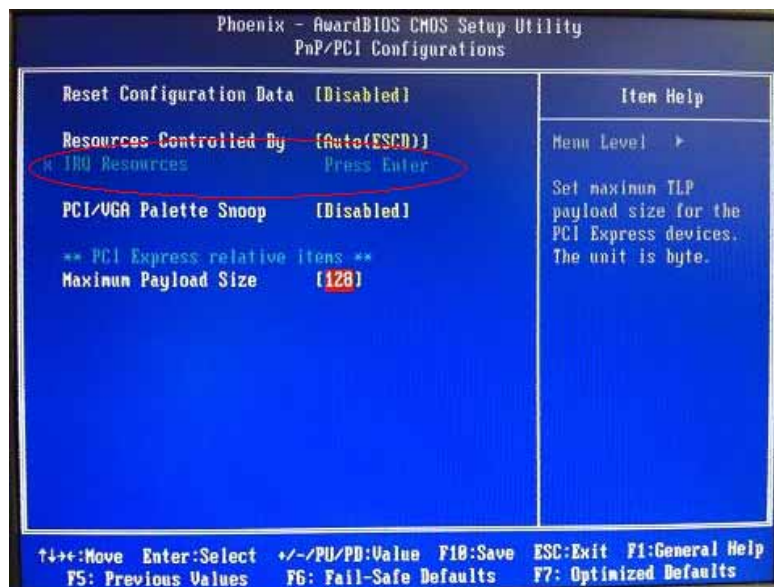

● **PCI/VGA Palette Snoop**

Some non-standard VGA display cards may not show colors properly. This item allows you to set whether MPEG ISA/VESA VGA Cards can work with PCI/VGA or not. When enabled, a PCI/VGA can work with a MPEG ISA/VESA VGA card; when disabled, a PCI/VGA cannot work with a MPEG ISA/VESA Card.

**\*\* PCI Express relative items**

\*\*

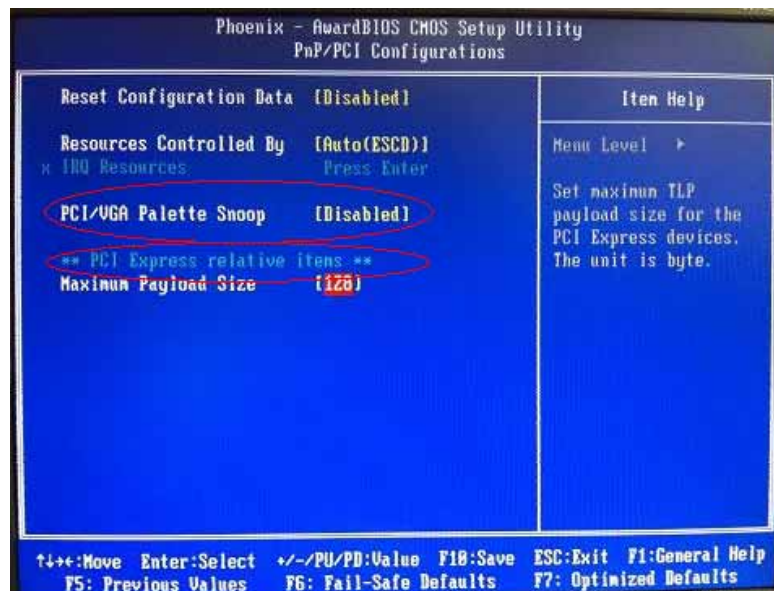

- **Maximum Payload Size**

When using DDR SDRAM and Buffer size selection, another consideration in designing a payload memory is the size of the buffer for data storage. Maximum Payload Size defines the maximum TLP (Transaction Layer Packet) data payload size for the device.

Press <Esc> to return to the Main Menu page.



### 3.11 PC Health Status

This section supports hardware monitoring that lets you monitor those parameters for critical voltages, temperatures and fan speed of the board.

Press <Esc> to return to the Main Menu page.

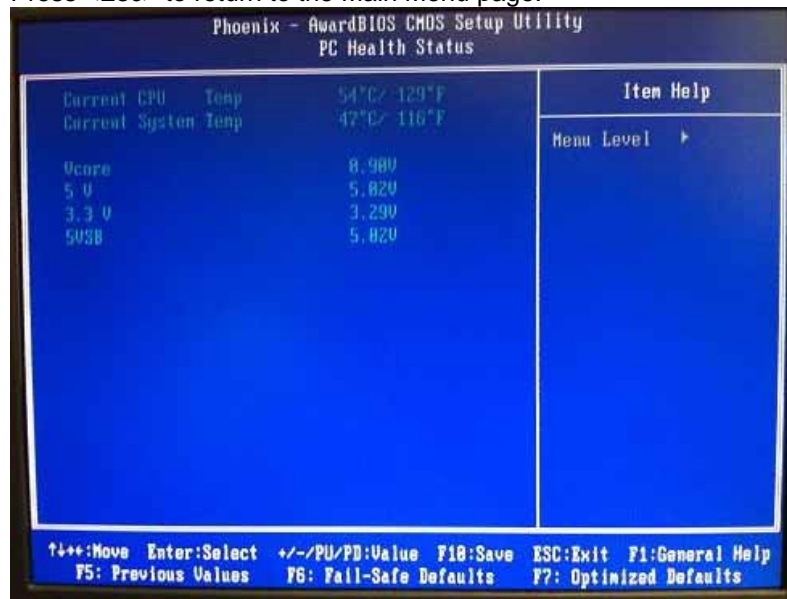

### 3.12 Load Optimized Defaults

This option allows you to load your system configuration with default values. These default settings are optimized to enable high performance features.

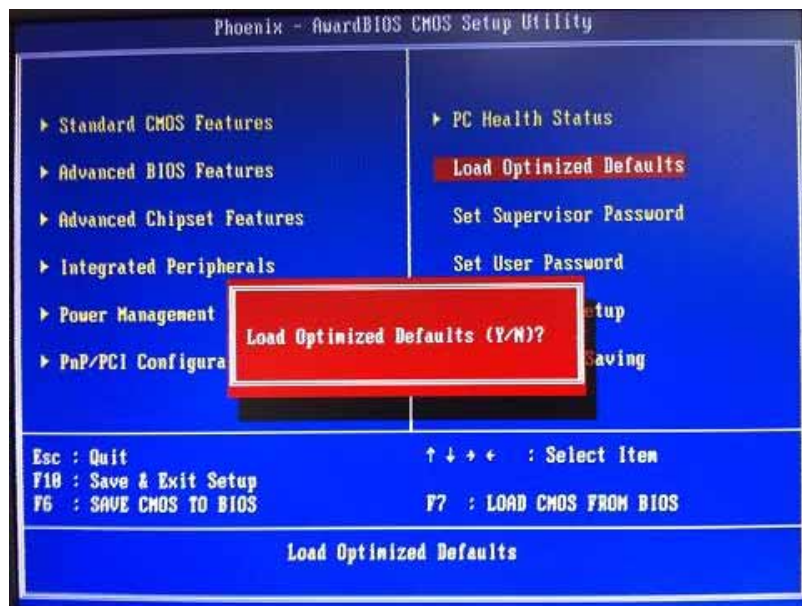

To load CMOS SRAM with SETUP default values, please enter "Y". If not, please enter "N".

### **3.13 Set Supervisor/User Password**

You can set a supervisor or user password, or both of them. The differences between them are:

- 1 **Supervisor password:** You can enter and change the options on the setup menu.
- 2 **User password:** You can just enter, but have no right to change the options on the setup menu.

When you select this function, the following message will appear at the center of the screen to assist you in creating a password.

#### **ENTER PASSWORD**

Type a maximum eight-character password, and press <Enter>. This typed password will clear previously entered password from the CMOS memory. You will be asked to confirm this password. Type this password again and press <Enter>. You may also press <Esc> to abort this selection and not enter a password.

To disable the password, just press <Enter> when you are prompted to enter a password. A message will confirm the password is getting disabled. Once the password is disabled, the system will boot and you can enter Setup freely.

#### **PASSWORD DISABLED**

When a password is enabled, you have to type it every time you enter the Setup. It prevents any unauthorized persons from changing your system configuration.

Additionally, when a password is enabled, you can also require the BIOS to request a password every time the system reboots. This would prevent unauthorized use of your computer.

You decide when the password is required for the BIOS Features Setup Menu and its Security option. If the Security option is set to "System", the password is required during booting up and entry into the Setup; if it is set as "Setup", a prompt will only appear before entering the Setup.





### 3.14 Save & Exit Setup

This section allows you to determine whether or not to accept your modifications. Type "Y" to quit the setup utility and save all changes into the CMOS memory. Type "N" to bring you back to the **Previous Setup utility**.

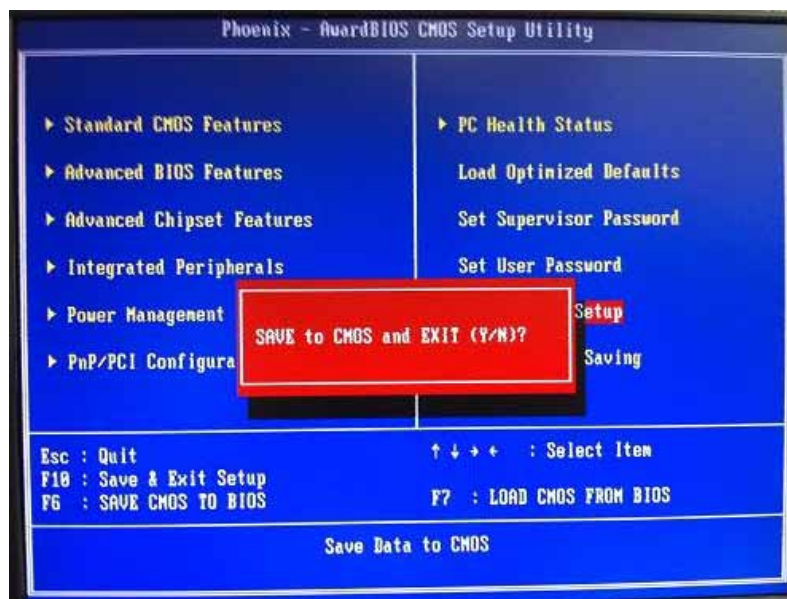

### 3.15 Exit Without Saving

Select this option to exit the Setup utility without saving changes you have made in this session. Type "Y", and it will quit the Setup utility without saving your modifications and come back to **Previous Setup utility**. Type "N" to return to the *Setup utility*.

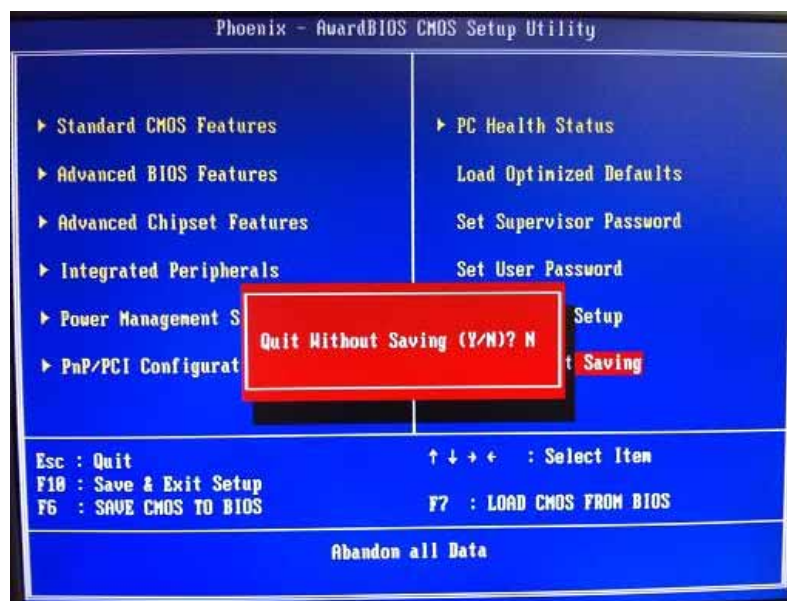

## CHAPTER 4 INSTALLATION OF DRIVERS

### 4.1 INSTALLATION OF LAN DRIVER UPDATE

- 4.1.1 My Computer Press the right key of Mouse  
→ Properties Hardware Device Manager Network  
adapters Update Driver (Refer below Picture-1)

(Picture-1)

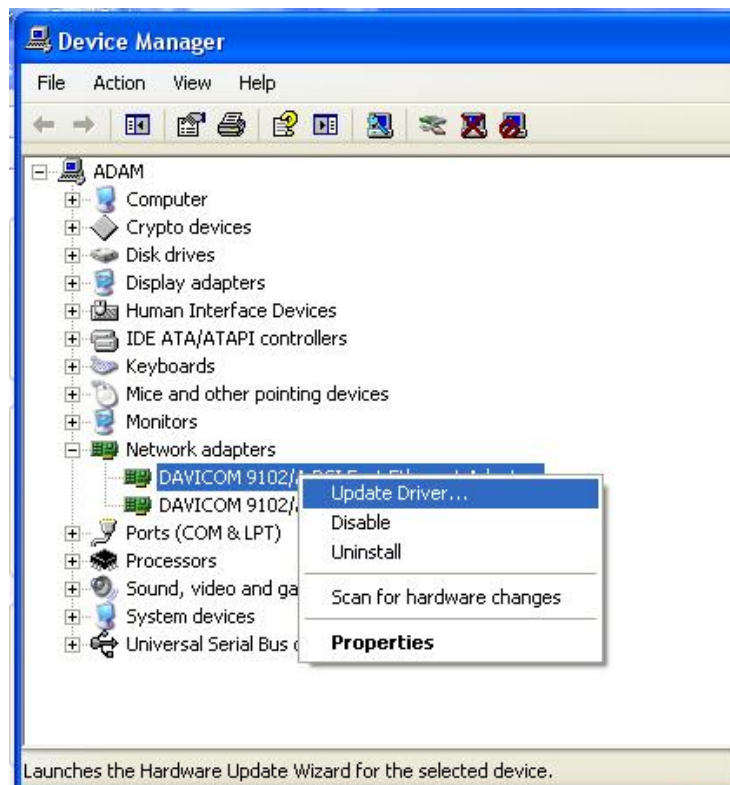

- 4.1.2 Install from a list or specific location Include this location in the search (Pls refer below Picture-2)

(Picture-2)

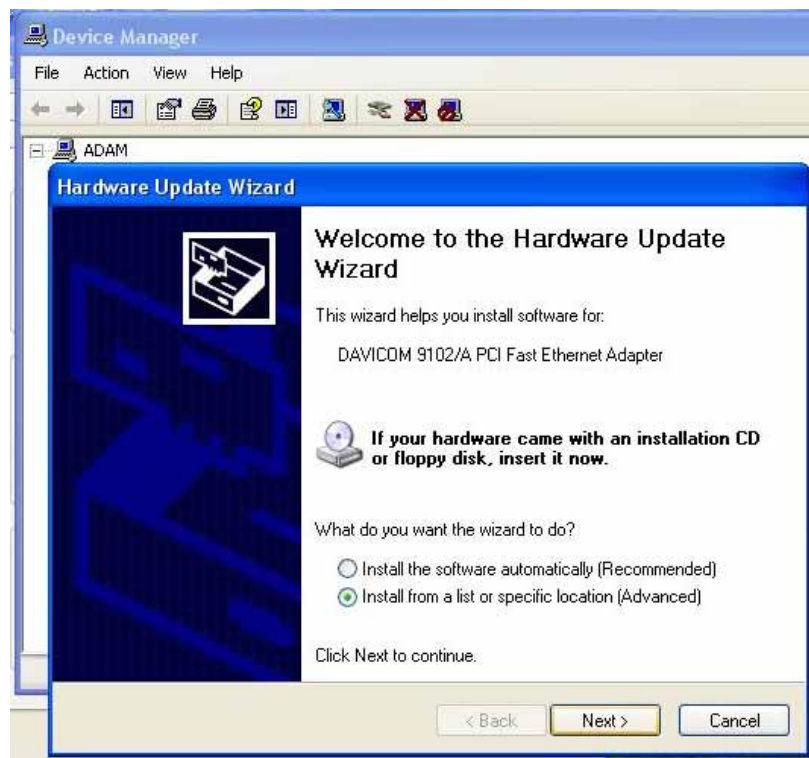

**4.1.3 Don't search I will choose the driver to install "Next"**  
(Pls refer below Picture-3)

**(Picture-3)**

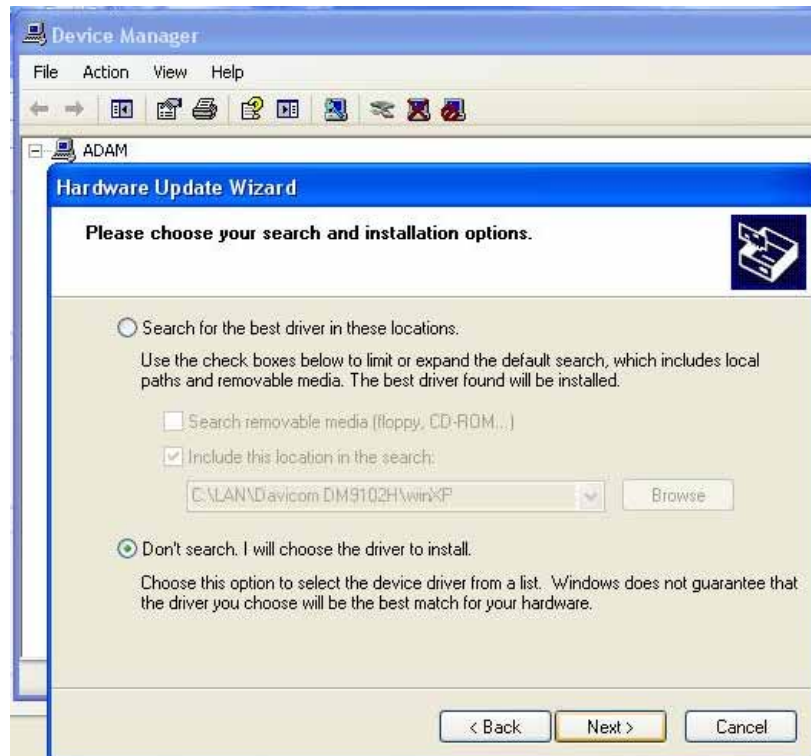

4.1.4 Select "Have Disk.." (Pls refer below Picture-4)

(Picture-4)

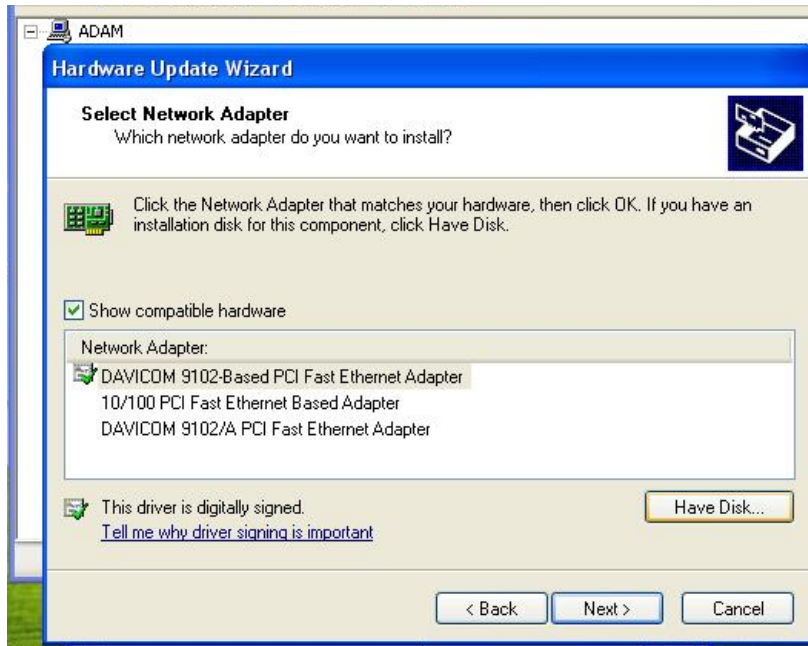

4.1.5 Select "Browse.." (Pls refer below Picture-5)

(Picture-5)



**4.1.6** Choose the file location loop on CD file as follow  
E:\Drivers\LAN\Davicom DM9102H\winXP\netdmA (Pls refer below Picture-6)

**(Picture-6)**

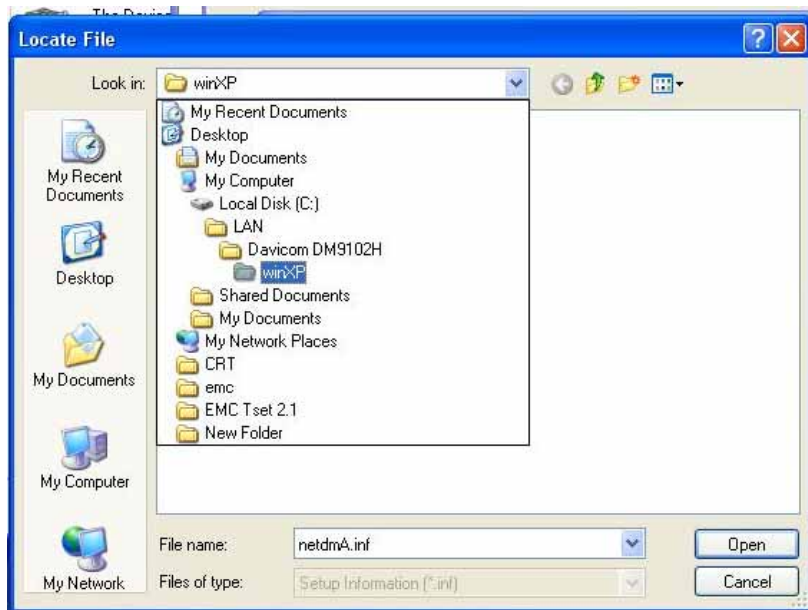



4.1.7 Select "OK" (Pls refer below Picture-7)

(Picture-7)



**4.1.8** Choose DAVICOM 9102/A PCI Fast Ethernet Adapter  
"Next" (Pls refer below Picture-8)

**(Picture-8)**



4.1.9 Select “Continue Anyway” (Pls refer below Picture-9)

(Picture-9)



**4.1.10** Select “Finish” (Pls refer below Picture-10)

**(Picture-10)**

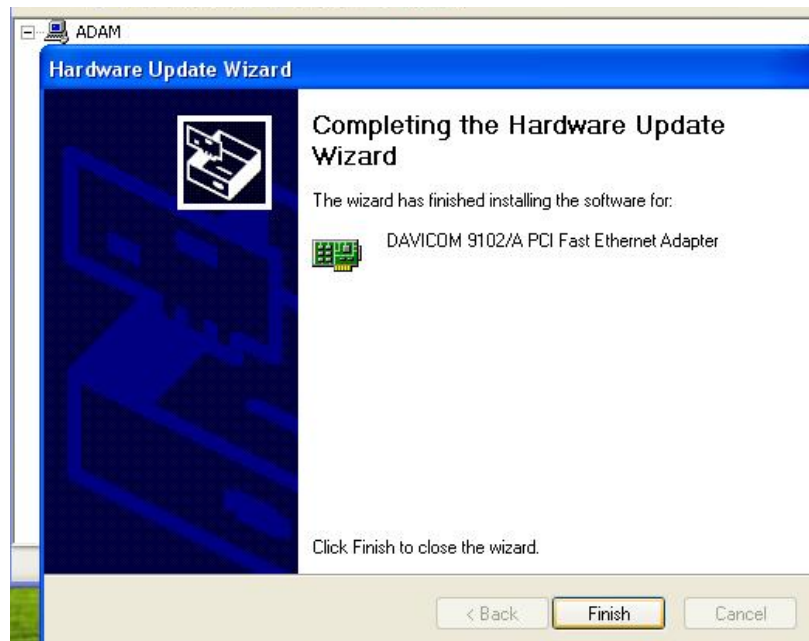

4.1.11 Select “Properties” (Pls refer below Picture-11)

(Picture-11)

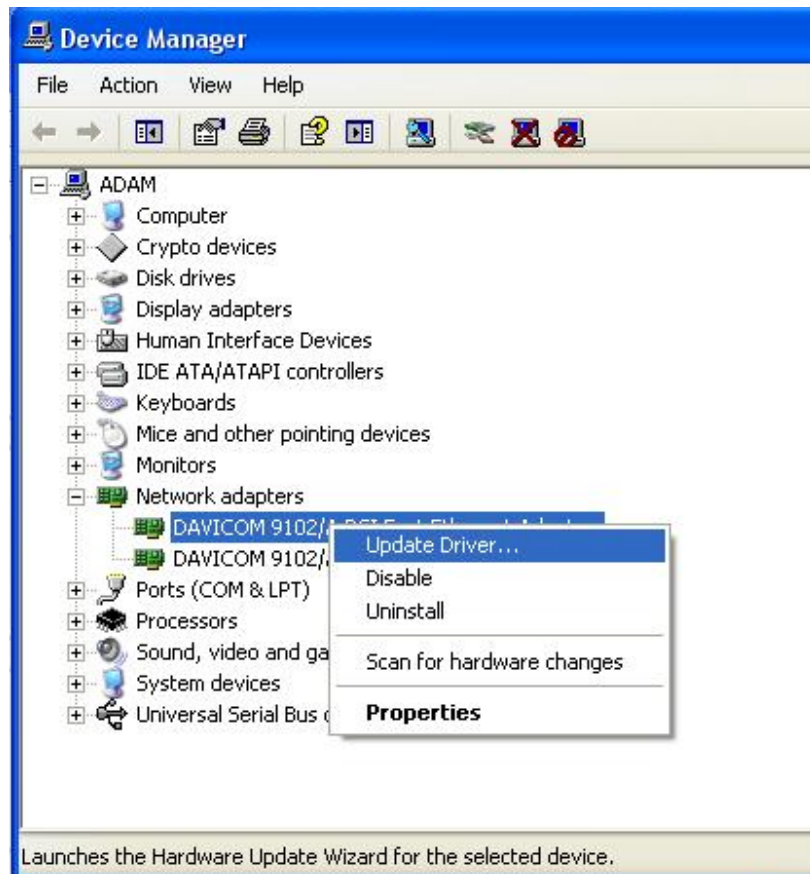

**4.1.12** Check the Advance WakeUp on APM Mode Value is Disable (Pls refer below Picture-12)

**(Picture-12)**

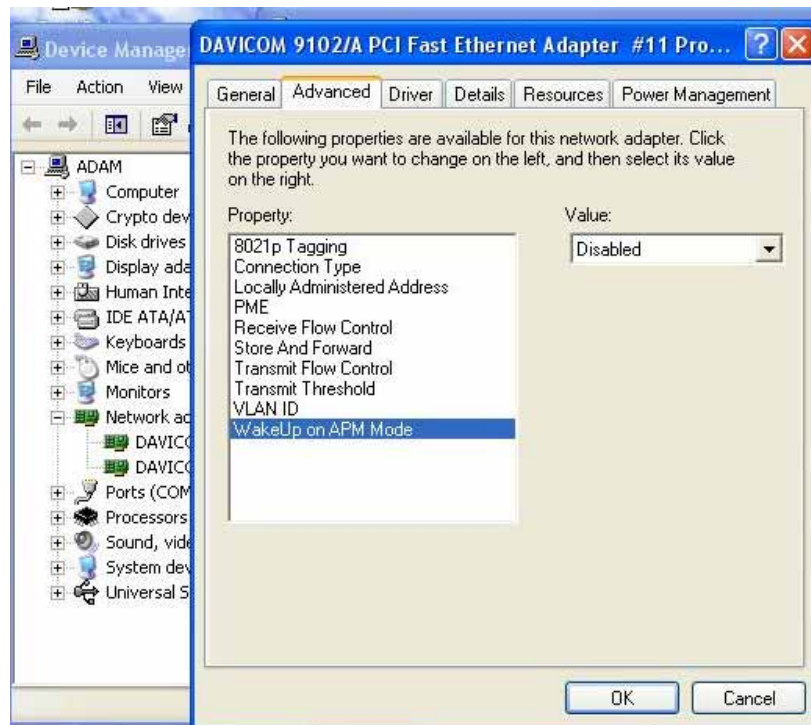

## **4.2 NOTICE FOR INSTALLATION OF DRIVER**

### **\*\* NOTICE \*\***

Two graphics drivers, but only one can be installed in the system.

- **Windows XP GMA 500 driver**

The default setting of display output under Windows XP GMA 500 driver is LVDS port.

If you only connect VGA port to install driver, please press "**Ctrl+Alt+F1**" to switch the display output to VGA port.

- **Windows XP IEGD driver**

The default setting of display output is VGA port.

***MEMO***